

15-213

"The course that gives CMU its Zip!"

Verifying Programs with BDDs Sept. 22, 2006

Topics

- Representing Boolean functions with Binary Decision Diagrams
- Application to program verification

class08-bdd.ppt

15-213, F'06

Verification Example

```
int abs(int x) {  
    int mask = x>>31;  
    return (x ^ mask) + ~mask + 1;  
}
```

```
int test_abs(int x) {  
    return (x < 0) ? -x : x;  
}
```

Do these functions produce identical results?

How could you find out?

How about exhaustive testing?

- 2 -

More Examples

```
int addXY(int x, int y) {  
    return x+y;  
}  
?  
=  
int addYX(int x, int y) {  
    return y+x;  
}
```

```
int mulXY(int x, int y) {  
    return x*y;  
}  
?  
=  
int mulYX(int x, int y) {  
    return y*x;  
}
```

- 3 -

How Can We Verify Programs?

Testing

- Exhaustive testing not generally feasible
- Currently, programs only tested over small fraction of possible cases

Formal Verification

- Mathematical "proof" that code is correct

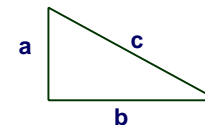

- Did Pythagoras show that $a^2 + b^2 = c^2$ by testing?

- 4 -

Bit-Level Program Verification

```
int abs(int x) {
    int mask = x >> 31;
    return (x ^ mask) + ~mask + 1;
}
```

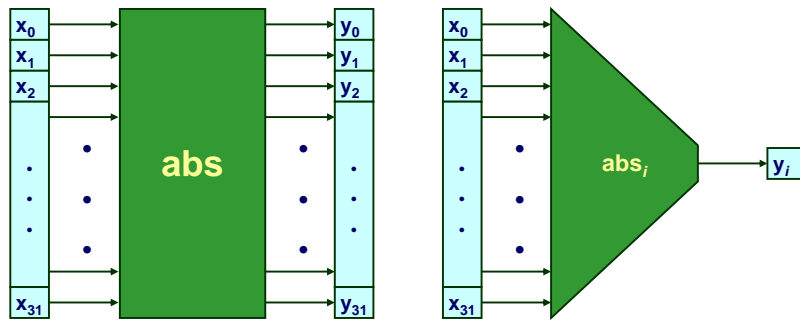

- View computer word as 32 separate bit values
- Each output becomes Boolean function of inputs

-5-

Extracting Boolean Representation

```
int bitOr(int x, int y)
{
    return ~(~x & ~y);
}
```

```
int test_bitOr(int x, int y)
{
    return x | y;
}
```

Do these functions produce identical results?

Straight-Line Evaluation

x
y
v1 = ~x
v2 = ~y
v3 = v1 & v2
v4 = ~v3
v5 = x y
t = v4 == v5

-6-

Tabular Function Representation

x ₁	x ₂	x ₃	f
0	0	0	0
0	0	1	0
0	1	0	0
0	1	1	1
1	0	0	0
1	0	1	1
1	1	0	0
1	1	1	1

- List every possible function value

Complexity

- Function with n variables

-7-

Algebraic Function Representation

x ₁	x ₂	x ₃	f
0	0	0	0
0	0	1	0
0	1	0	0
0	1	1	1
1	0	0	0
1	0	1	1
1	1	0	0
1	1	1	1

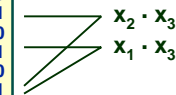

- $f(x_1, x_2, x_3) = (x_1 + x_2) \cdot x_3$
- Boolean Algebra

Complexity

- Representation
- Determining properties of function
 - E.g., deciding whether two expressions are equivalent

-8-

Tree Representation

Truth Table

x_1	x_2	x_3	f
0	0	0	0
0	0	1	0
0	1	0	0
0	1	1	1
1	0	0	0
1	0	1	1
1	1	0	0
1	1	1	1

Decision Tree

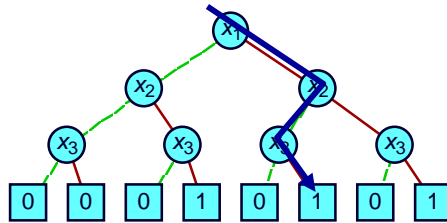

- Vertex represents decision
- Follow green (dashed) line for value 0
- Follow red (solid) line for value 1
- Function value determined by leaf value

Complexity

Ordered Binary Decision Diagrams

Initial Tree

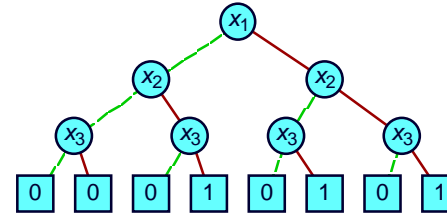

Reduced Graph

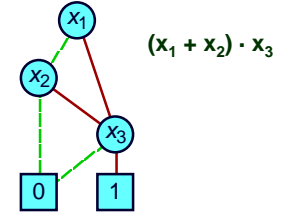

Canonical representation of Boolean function

- Two functions equivalent if and only if graphs isomorphic
 - Can be tested in linear time
- Desirable property: *simplest form is canonical.*

Example Functions

Constants

- 0 Unique unsatisfiable function
- 1 Unique tautology

Variable



Typical Function

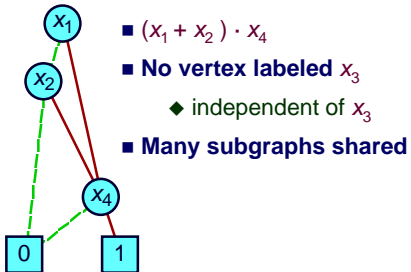

- $(x_1 + x_2) \cdot x_4$
- No vertex labeled x_3
 - ◆ independent of x_3
- Many subgraphs shared

Odd Parity

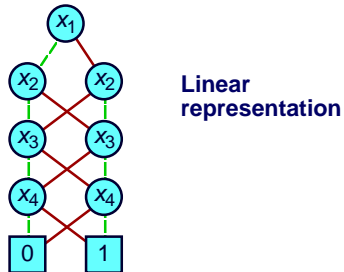

More Complex Functions

Functions

- Add 4-bit words a and b
- Get 4-bit sum s
- Carry output bit $Cout$

Shared Representation

- Graph with multiple roots
- 31 nodes for 4-bit adder
- 571 nodes for 64-bit adder
- Linear growth!

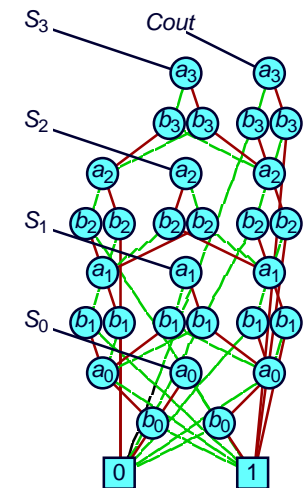

Symbolic Execution

(3-bit word size)

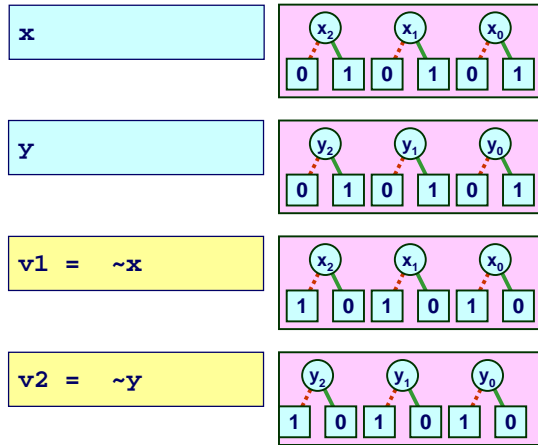

Symbolic Execution (cont.)

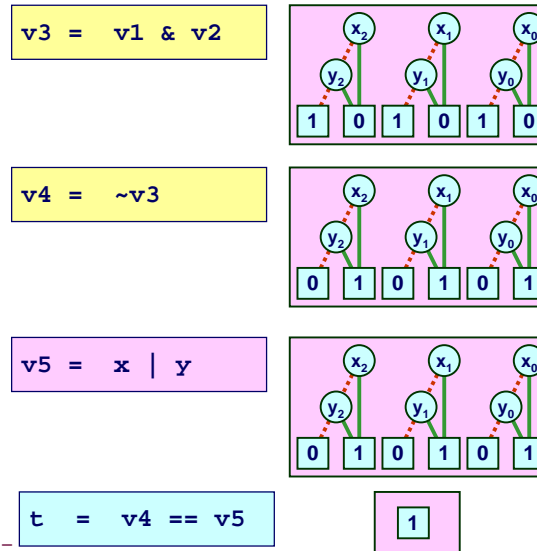

Counterexample Generation

Straight-Line Evaluation

```
int bitOr(int x, int y)
{
    return ~(~x & ~y);
}
```

```
int bitXor(int x, int y)
{
    return x ^ y;
}
```

Find values of x & y for which these programs produce different results

x
y
$v1 = \sim x$
$v2 = \sim y$
$v3 = v1 \& v2$
$v4 = \sim v3$
$v5 = x \wedge y$
$t = v4 == v5$

Symbolic Execution

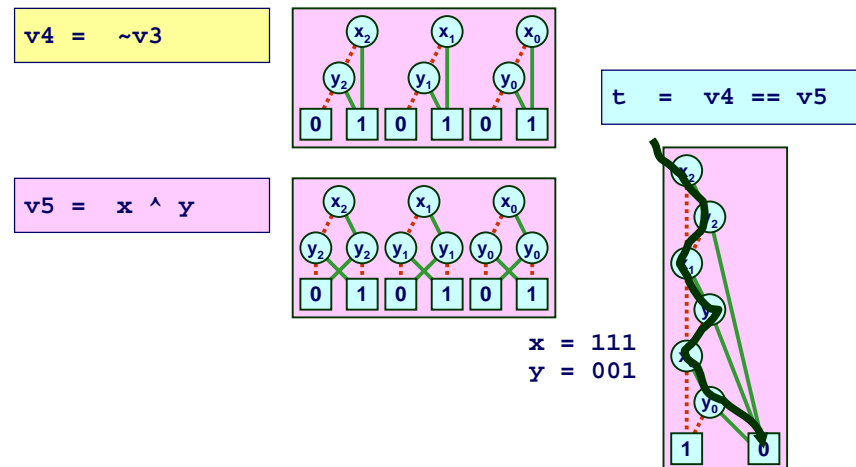

Performance: Good

```
int addXY(int x, int y)
{
    return x+y;
}
```

```
int addYX(int x, int y)
{
    return y+x;
}
```

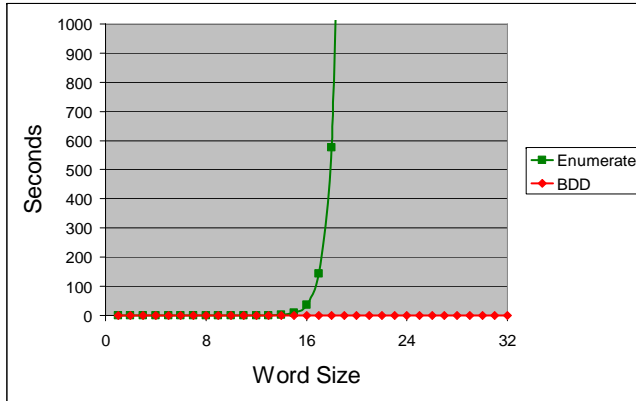

- 17 -

Performance: Bad

```
int mulXY(int x, int y)
{
    return x*y;
}
```

```
int mulYX(int x, int y)
{
    return y*x;
}
```

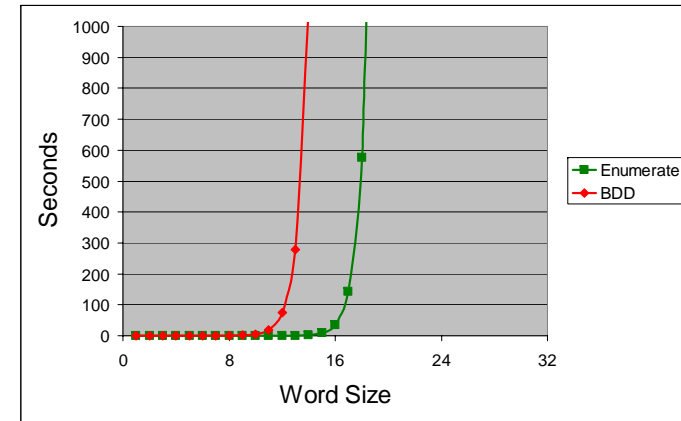

- 18 -

Why Is Multiplication Slow?

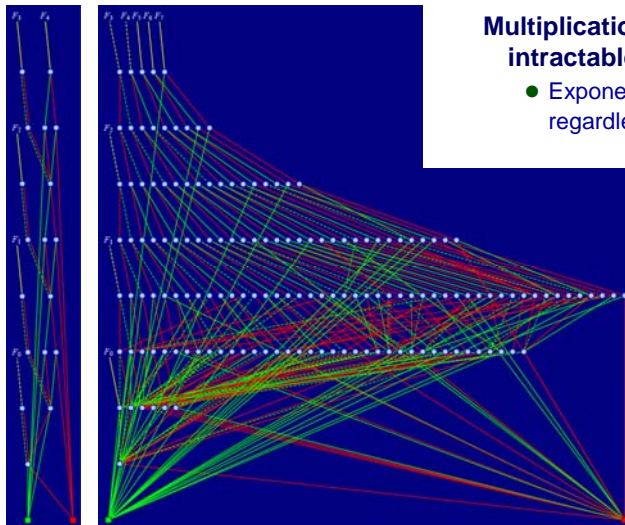

Multiplication function intractable for BDDs

- Exponential growth, regardless of variable ordering

Node Counts

Bits	Add	Mult
4	21	155
8	41	14560

Add-4

Multiplication-4

What if Multiplication were Easy?

```
int factorK(int x, int y)
{
    int K = XXXX...X;
    int rangeOK =
        1 < x && x <= y;
    int factorOK =
        x*y == K;
    return
        !(rangeOK && factorOK);
}
```

```
int one(int x, int y)
{
    return 1;
}
```

- 20 -

Dealing with Conditionals

```
int abs(int x)
{
  int r;
  if (x < 0)
    r = -x;
  else
    r = x;
  return r;
}
```

		r	
	Context defined	defined	value
x	1	0	0
t1 = x < 0	1	0	0
v1 = -x	t1	0	0
r = v1	t1	t1	t1?v1:0
r = x	!t1	1	t1?v1:x
v2 = r	1	1	t1?v1:x

During Evaluation, Keep Track of:

- **Current Context:** Under what condition would code be evaluated
- **Definedness (for each variable)**
 - Has it been assigned a value

- 21 -

Dealing with Loops

```
int ilog2(unsigned x)
{
  int r = -1;
  while (x) {
    r++; x >>= 1;
  }
  return r;
}
```

Unrolled

```
int ilog2(unsigned x)
{
  int r = 31;
  if (x) {
    r++; x >>= 1;
  } else return r;
  if (x) {
    r++; x >>= 1;
  } else return r;
  . . .
  if (x) {
    r++; x >>= 1;
  } else return r;
  error();
}
```

Unroll

- **Turn into bounded sequence of conditionals**
 - Default limit = 33
- **Signal runtime error if don't complete within limit**

- 22 -

Evaluation

Strengths

- Provides 100% guarantee of correctness
- Performance very good for simple arithmetic functions

Weaknesses

- Important integer functions have exponential blowup
- Not practical for programs that build and operate on large data structures

- 23 -

Some History

Origins

- **Lee 1959, Akers 1976**
 - Idea of representing Boolean function as BDD
- **Hopcroft, Fortune, Schmidt 1978**
 - Recognized that ordered BDDs were like finite state machines
 - Polynomial algorithm for equivalence
- **Bryant 1986**
 - Proposed as useful data structure + efficient algorithms
- **McMillan 1987**
 - Developed symbolic model checking
 - Method for verifying complex sequential systems
- **Bryant 1991**
 - Proved that multiplication has exponential BDD
 - No matter how variables are ordered

- 24 -